

STACKABLE BROOKS BOXES
AVAILABLE IN 36", 24" AND
6" HEIGHTS

36" I.D. MANHOLE BARREL

**ASSEMBLY DEPICTING
4FT OF BURY**

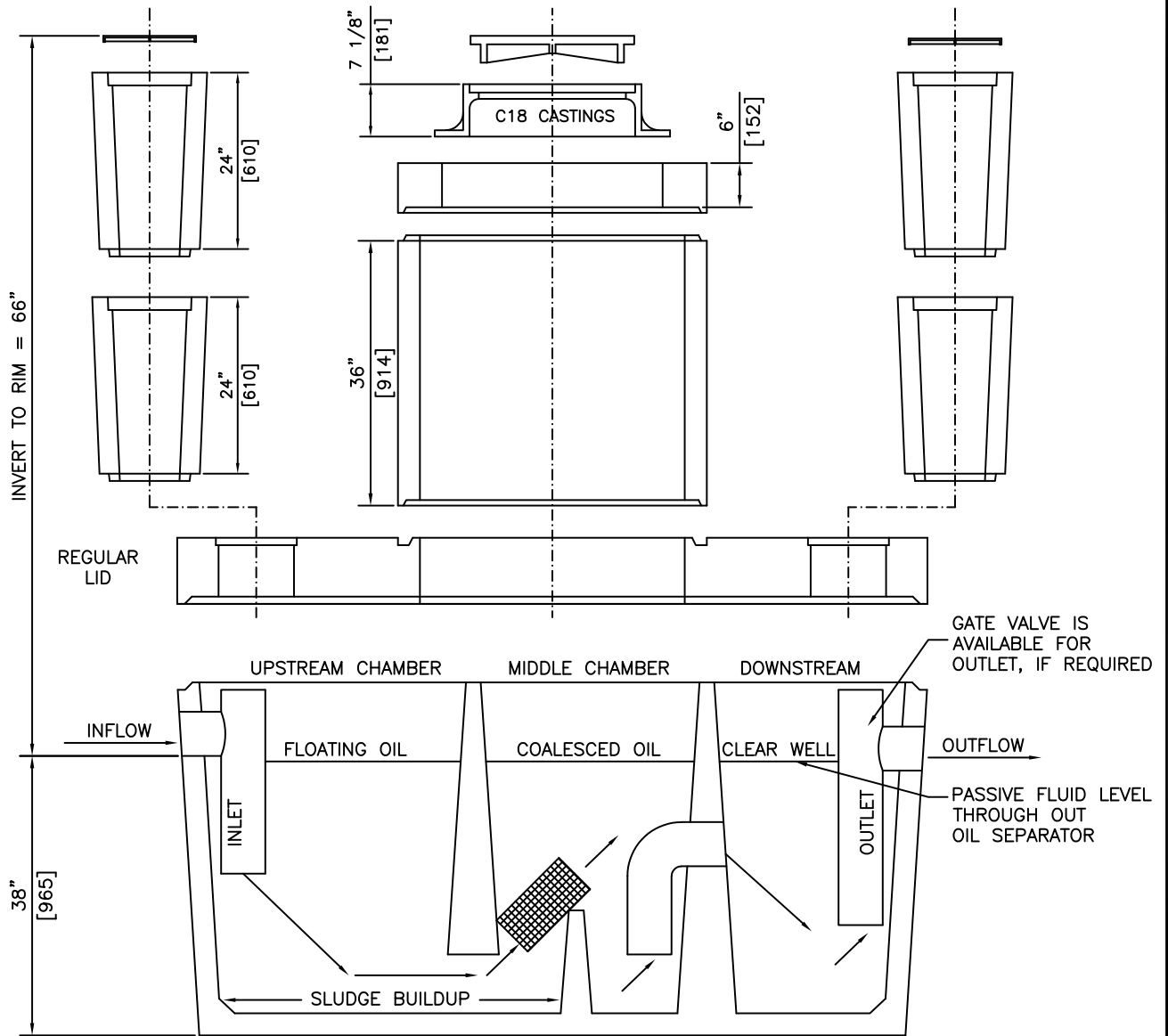

**INSTALLATION SEQUENCE
AND OPERATION DETAILS**

NOTES:

U.S. PATENT No. 6,079,571
CANADIAN PATENT No. 2,252,307

REGULAR 600
GALLON OIL
INTERCEPTOR TANK

REVISED: MAR 17 2006

<p>A.F.C. AMERICAN FORCECRETE OF CANADA Inc.</p>	<p>3891 Irvine Road LAKE COUNTRY, B.C. V4V 2G4 PH: (250) 548-0056 FX: (250) 765 0820</p>	<p>BY: PKR DATE: MAR 17 06 SCALE: NTS</p>	<p>AFC OIL/WATER SEPARATOR 150GPM</p>	<p>ITEM NO.</p>